

# WARRIORS

## NIGHT FORCE™



**N-373**  
**OPTIC™**

*Missiles really fire!*

*¡Los misiles se disparan de verdad!*

*Les missiles peuvent être lancés!*

*Raketten vliegen echt!*

GLOW-IN-THE-DARK CAMO STIK™!  
• CAMO STIK™ FOSFORESCENTE!  
• CAMO STIK™ PHOSPHORESCENT!  
• FLUORESCERENDE CAMO STIK™!

Ages/Años  
Áges/Leeftijd

Pieces/Piezas  
Pièces/Stuks

7+

270

	<b>10x</b>	M0910Y
	<b>8x</b>	M1322F
	<b>8x</b>	M1322JG
	<b>12x</b>	M1323JG
	<b>4x</b>	M1323Y
	<b>16x</b>	M1323F
	<b>4x</b>	M1417JG
	<b>4x</b>	M1417F
	<b>2x</b>	M1418JG
	<b>2x</b>	M1418F
	<b>3x</b>	AS0952825
	<b>13x</b>	M10273F
	<b>8x</b>	M10273JG
	<b>5x</b>	M1154JG
	<b>6x</b>	M1154F

	<b>10x</b>	M1139F
	<b>9x</b>	M09013F
	<b>10x</b>	M1087F
	<b>3x</b>	M1480F
	<b>2x</b>	M09023F
	<b>3x</b>	AS0952822
	<b>3x</b>	M09023JG
	<b>9x</b>	M09033JG
	<b>19x</b>	M09033F
	<b>2x</b>	M10233JG
	<b>2x</b>	M1314JG
	<b>4x</b>	M09593F
	<b>12x</b>	M09493F
	<b>4x</b>	M09493JG

	<b>6x</b>	M02250Y
	<b>2x</b>	M02250F
	<b>4x</b>	M0948F
	<b>4x</b>	M1113Y
	<b>2x</b>	M11241JG
	<b>4x</b>	M11241F
	<b>3x</b>	M1312F
	<b>1x</b>	M1346F
	<b>1x</b>	M11631F
	<b>1x</b>	M11632F
	<b>2x</b>	M1390F
	<b>1x</b>	M1172F
	<b>2x</b>	AS0952823
	<b>2x</b>	AM02237F

	<b>1x</b>	AS0952921
	<b>1x</b>	AS0952922
	<b>3x</b>	AM01797MM
	<b>4x</b>	AS095913
	<b>2x</b>	M11161F
	<b>2x</b>	M11162F
	<b>1x</b>	M1367Y
	<b>1x</b>	M1142F
	<b>1x</b>	AM01531JG
	<b>2x</b>	M1141F
	<b>2x</b>	M11101F
	<b>2x</b>	M1137JG
	<b>7x</b>	M1320Y

	<b>1x</b>	M1304F
	<b>4x</b>	M1367F
	<b>2x</b>	M1155F
	<b>2x</b>	AM01809JG
	<b>1x</b>	AS0952912
	<b>2x</b>	AM02324KG
	<b>2x</b>	AM01749JG
	<b>2x</b>	X095293
	<b>3x</b>	AS0952824
	<b>2x</b>	AS0952917
	<b>1x</b>	AS0952915
	<b>1x</b>	AS0952914

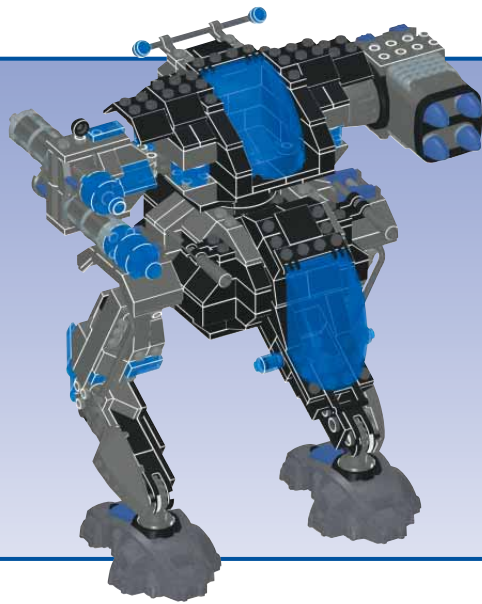

Color chart.

Charte de couleurs.

Cuadro cromático.

Quadro cromatico.

Färgtabell.

Kleurenkaart.

カラーチャート

色彩表

Active step / Étape active / Etapa activa / Azione attiva  
Aktivt skede / Actieve stap / アクティブなステップ / 積極步驟

Previous step / Étape précédente / Etapa precedente  
Azione precedente / Föregående skedet / Vorige stap  
前のステップ / 上一步驟

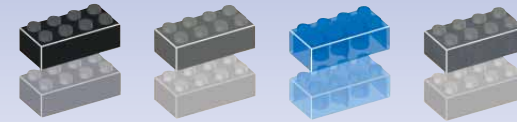

**EN** ⚠ **WARNING :**  
**CHOKING HAZARD.** - Small parts.  
Not for children under 3 years.

**ES** ⚠ **ADVERTENCIA :**  
**PELIGRO DE ASFIXIA.** - Contiene piezas pequeñas.  
No recomendado para niños menores de 3 años.

**FR** ⚠ **AVERTISSEMENT :**  
**RISQUE DE SUFFOCATION.** - Présence de petits éléments.  
Ne convient pas aux enfants de moins de 3 ans.

**NL** ⚠ **WAARSCHUWING:**  
**VERSTIKKINGSGEVAAR.** - Bevat kleine onderdelen.  
Niet geschikt voor kinderen onder de 3 jaar.

**DE** ⚠ **WARNING:**  
**ERSTICKUNGSGEFAHR.** - Enthält kleine Teile.  
Nicht für Kinder unter 3 Jahren geeignet.

**DA** ⚠ **ADVARSEL:**  
**KVÆLNINGSFARE.** - Indeholder smådele.  
Ikke til børn under 3 år.

**EL** ⚠ **ΠΡΟΕΙΔΟΠΟΙΗΣΗ:**  
**ΚΙΝΔΥΝΟΣ ΠΝΙΞΙΜΑΤΟΣ.** - Περιέχει μικρά αντικείμενα.  
Όχι για παιδιά κάτω των 3 ετών.

**FI** ⚠ **VAROITUS:**  
**TUKEHTUMISVAARA.** - Sisältää pieniä osia.  
Ei alle 3-vuotiaille lapsille.

**IT** ⚠ **ATTENZIONE:**  
**PERICOLO DI SOFFOCAMENTO.** - Contiene piccole parti.  
Non indicato per bambini sotto i 3 anni.

**NO** ⚠ **ADVARSEL:**  
**KVELNINGSFARE.** - Inneholder små deler.  
Kun for barn over 3 år.

**PT** ⚠ **ATENÇÃO:**  
**PERIGO DE ASFIXIA.** - Contém peças pequenas.  
Não é concebido para crianças de menos de 3 anos.

**SV** ⚠ **WARNING!**  
**KVÄVNINGSRISK.** - Innehåller små delar.  
Inte för barn under 3 år.

**JA** ⚠ **警告 :**  
窒息の危険性 小さな部品が含まれています  
3歳以下の子供には与えないで下さい。

**ZH** ⚠ **警告 :**  
有窒息危險。包含有小部件  
不适合3岁以下的小孩玩。

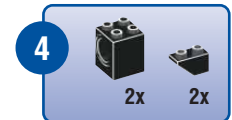
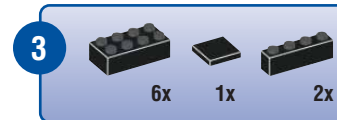
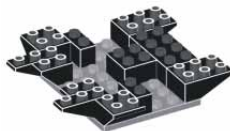
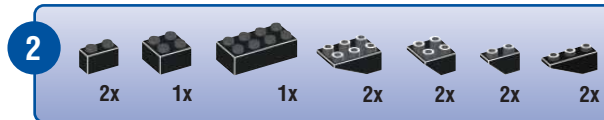
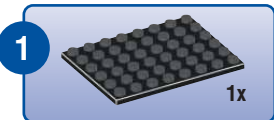



Active step / Étape active / Etapa activa / Azione attiva  
 Aktivt skede / Actieve stap / アクティブなステップ / 積極步驟  
 Previous step / Étape précédente / Etapa precedente  
 Azione precedente / Föregående skedet / Vorige stap  
 前のステップ / 上一步驟

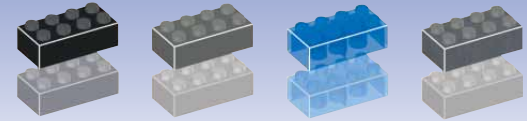

**5**

6x 2x

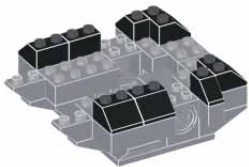

**6**

2x 3x 2x

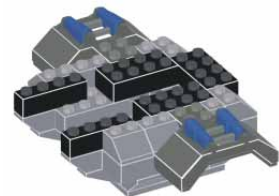

**7**

4x 2x 2x 1x 2x

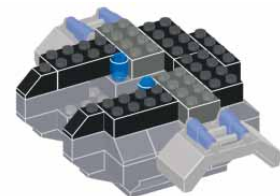

**8**

2x 2x 4x



**9**

1x 2x 2x 1x 6x

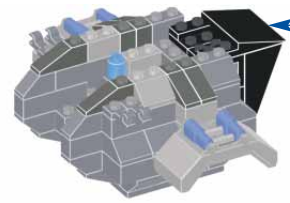

**1**

**2**

**3**

**10**

1x



**11**

2x 2x 1x



**12**

1x 1x 2x



**13**

2x 2x 1x



**14**

1x 2x 2x



**15**

2x 1x 2x



**16**

1x 2x



**17**

1x 1x



**18**

1x

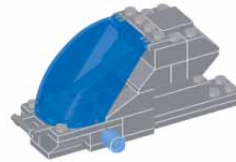

**19**

2x 2x 1 2 2x

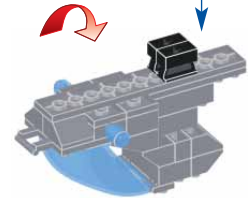

**20**

19 9

**21**

3x 1x 2x

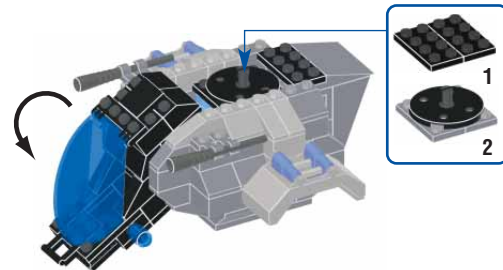

**22**

1x



**23**

1x 2x 2x

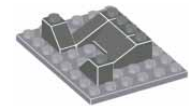



Active step / Étape active / Etapa activa / Azione attiva  
 Aktivt skede / Actieve stap / アクティブなステップ / 積極步驟  
 Previous step / Étape précédente / Etapa precedente  
 Azione precedente / Föregående skedet / Vorige stap  
 前のステップ / 上一步驟

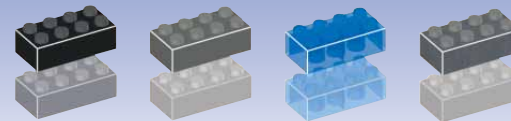

24



6x 4x

25

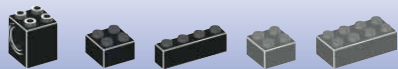

1x 1x 1x 1x 1x

26



1x 2x 2x 2x

27

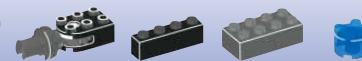

1x 1x 1x 4x



28

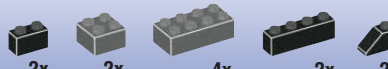

2x 2x 4x 2x 2x

29



12x

30

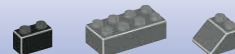

2x 1x 2x

31



1x 1x 2x 2x 2x

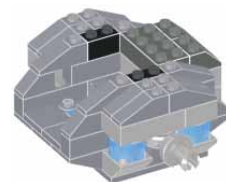
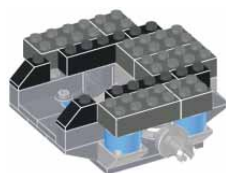

**32**

1x 2x 1x



**33**

1x

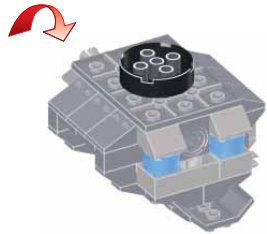

**34**

1x 1x 2x

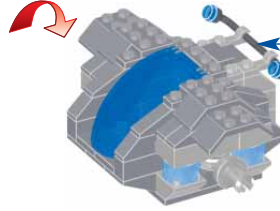

1 2

**35**

1x



**36**

1x 1x 1x



**37**

1x



**38**

1x 1x



**39**

1x 2x



**40**

1x 1x



**41**

1x



**42**

1x



**43**

1x 1x 1x



**44**

1x





Active step / Étape active / Etapa activa / Azione attiva  
 Aktivt skede / Actieve stap / アクティブなステップ / 積極步驟  
 Previous step / Étape précédente / Etapa precedente  
 Azione precedente / Föregående skedet / Vorige stap  
 前のステップ / 上一步驟

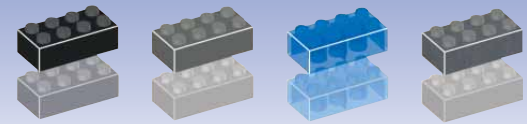

45

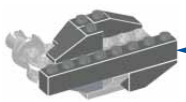
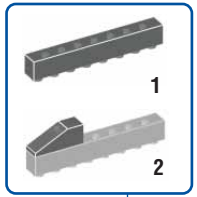

46



47



48



49



50



51

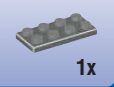

52



53

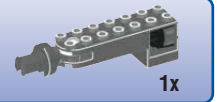



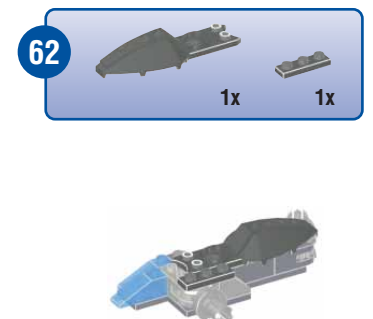
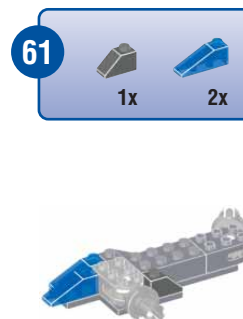
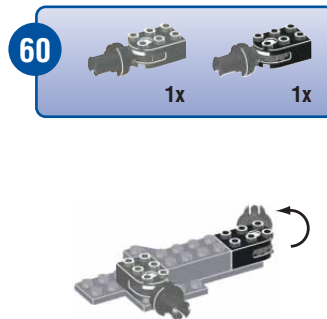
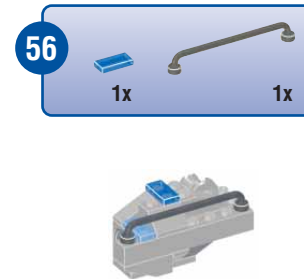
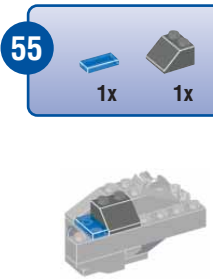
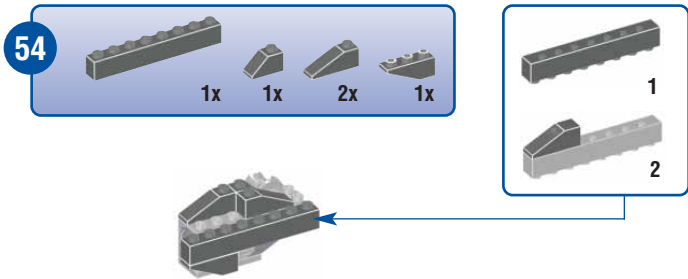



Active step / Étape active / Etapa activa / Azione attiva  
 Aktivt skede / Actieve stap / アクティブなステップ / 積極步驟  
 Previous step / Étape précédente / Etapa precedente  
 Azione precedente / Föregående skedet / Vorige stap  
 前のステップ / 上一步驟

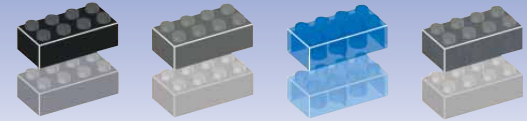

63



1x

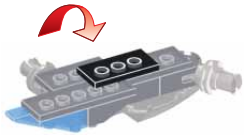

64

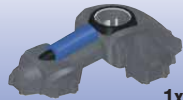

1x



65

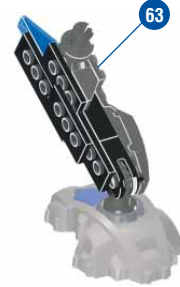

66



67



1x



68



1x

2x

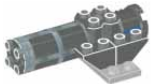

69



1x

1x



70



1x

1x

2x



71



2x

1x



72



1x

2x



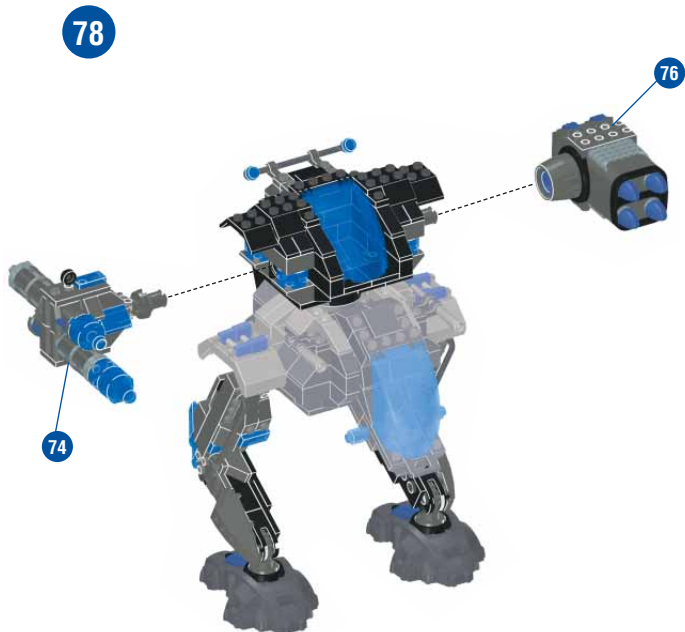
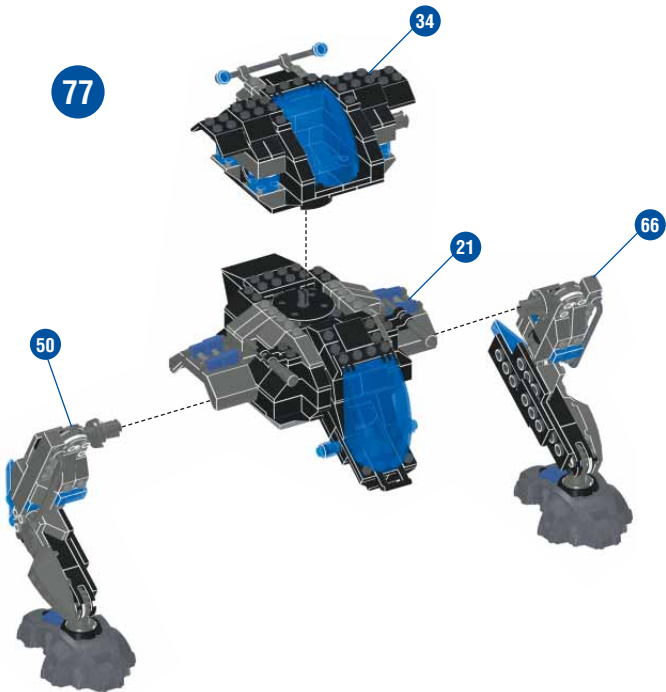
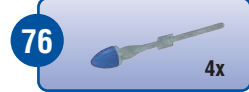
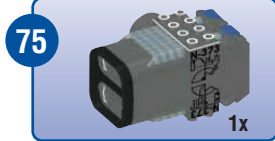
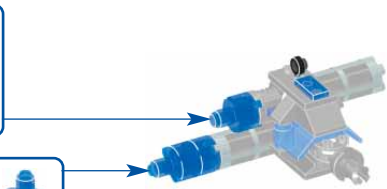
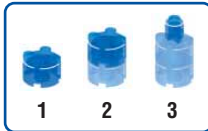

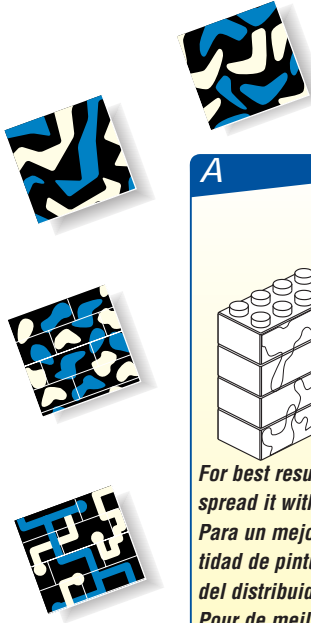

**A**

*For best results: Apply small amount of paint, then spread it with the tip. Paint drying time: 3 hours.*  
*Para un mejor resultado: Aplicar una pequeña cantidad de pintura a la base y extenderla con la punta del distribuidor. Tiempo de secado: 3 horas.*  
*Pour de meilleurs résultats: Appliquer une petite quantité de peinture à la fois et ensuite, l'étendre à l'aide de la buse. Temps de séchage: 3 heures.*

**B**

*Paint washes off blocks with tap water. La pintura es lavable al agua. La peinture est lavable à l'eau.*

**C**

*Dry paint can also be peeled off blocks or scraped off with the included block remover.*  
*Cuando esta seca, la pintura se puede quitar rascandola con el «saca-bloques».*  
*Une fois sèche, la peinture peut être pelée ou grattée à l'aide du «retire-bloc».*

**D**

*Replace paint tube cap firmly after use. Cerrar bien el tapón despues de la utilización. Bien refermer le bouchon après utilisation.*

**E**

*Use the block remover for disassembling. Utilizar el saca-bloques para facilitar el desmontaje. Utiliser le «retire-bloc» pour faciliter le désassemblage.*

**F**

**CAUTION ATENCION ATTENTION**  
*Paint may stain fabric and clothing. La pintura puede manchar los tejidos y la ropa. La peinture peut tacher les tissus et les vêtements.*

**G**

*To avoid injury, never launch projectiles in the direction of people or animals.*  
*No tirar o apuntar nunca en dirección o cerca de personas o animales.*  
*Ne jamais viser ou tirer les projectiles en direction ou près de gens ou d'animaux.*

**H**

*Use only MEGA BLOKS® projectiles. Utilizar solamente con los proyectiles MEGA BLOKS®. Utiliser seulement avec les projectiles MEGA BLOKS®.*